

Tief laden - hoch aufbauen:
mit »KramerKran Verlegesysteme«
neue Idee - neue Lösung

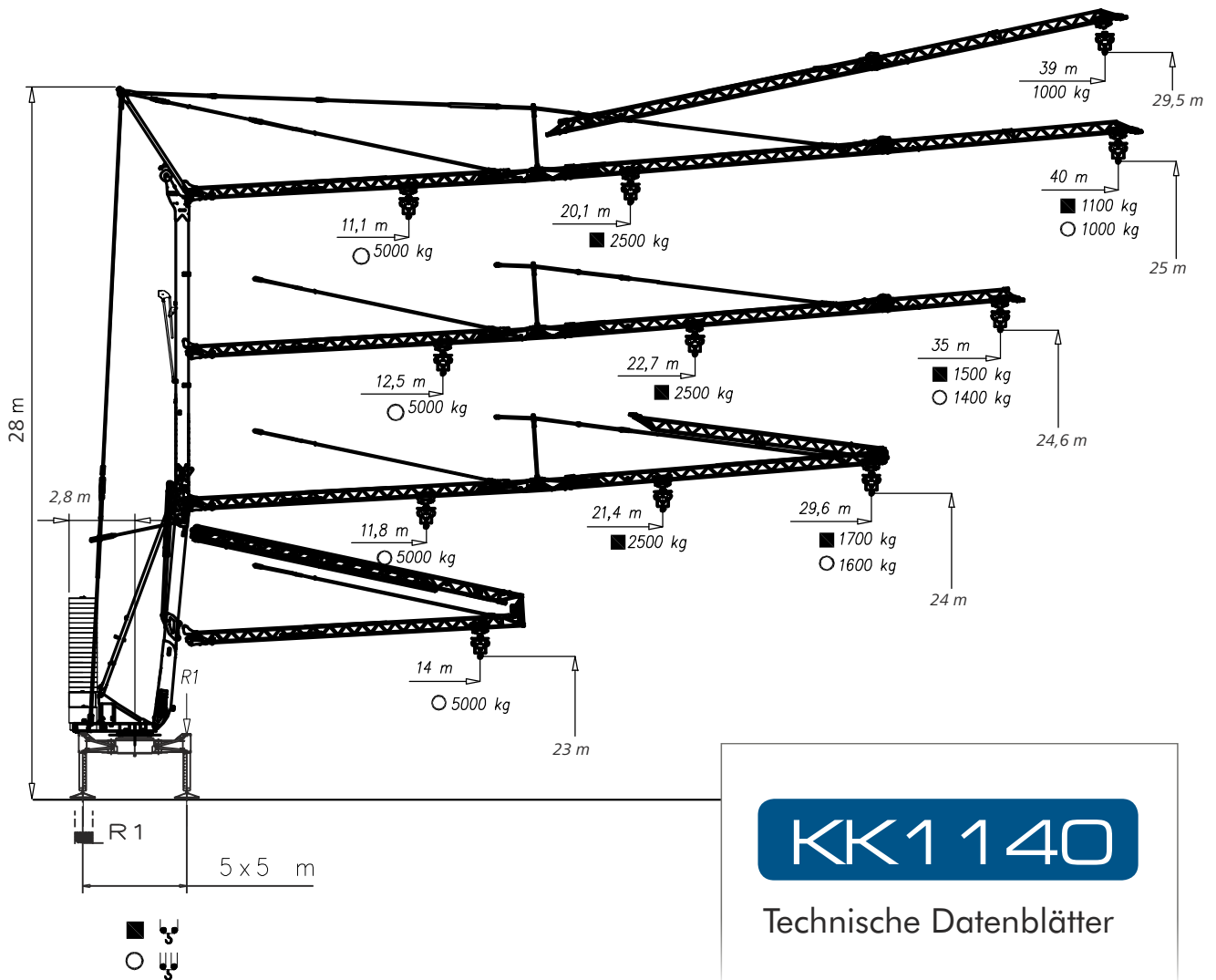

KK1140
Technische Datenblätter

HYDRAULISCHER SCHNELLMONTAGEKRAN
GRU A MONTAGGIO RAPIDO

GRUE A MONTAGE RAPIDE
GRUA DE RAPIDO MONTAJE

GRUA DE MONTAGEM RAPIDA
QUICK SELFERECTING CRANE

CE FEM 1.001 - A3

KK1 140

Lastkurven | Courbes de charges | Load diagrams | Curve di carico | Curvas de cargas

	<table border="1"> <tr> <td>3</td><td>20</td><td>39</td><td>m</td> </tr> <tr> <td>800</td><td>800</td><td>800</td><td>kg</td> </tr> </table>	3	20	39	m	800	800	800	kg	OP	<table border="1"> <tr> <td>3</td><td>20</td><td>39</td><td>m</td> </tr> <tr> <td>1000</td><td>1000</td><td>1000</td><td>kg</td> </tr> </table>	3	20	39	m	1000	1000	1000	kg																		
3	20	39	m																																		
800	800	800	kg																																		
3	20	39	m																																		
1000	1000	1000	kg																																		
	<table border="1"> <tr> <td>11,1</td><td>12</td><td>14</td><td>16</td><td>18</td><td>20</td><td>22</td><td>24</td><td>26</td><td>28</td><td>30</td><td>32</td><td>34</td><td>36</td><td>38</td><td>40</td><td>m</td> </tr> <tr> <td>5000</td><td>4540</td><td>3730</td><td>3150</td><td>2720</td><td>2390</td><td>2120</td><td>1910</td><td>1730</td><td>1570</td><td>1440</td><td>1330</td><td>1230</td><td>1150</td><td>1070</td><td>1000</td><td>kg</td> </tr> </table>	11,1	12	14	16	18	20	22	24	26	28	30	32	34	36	38	40	m	5000	4540	3730	3150	2720	2390	2120	1910	1730	1570	1440	1330	1230	1150	1070	1000	kg		
11,1	12	14	16	18	20	22	24	26	28	30	32	34	36	38	40	m																					
5000	4540	3730	3150	2720	2390	2120	1910	1730	1570	1440	1330	1230	1150	1070	1000	kg																					
	<table border="1"> <tr> <td>11,8</td><td>12</td><td>14</td><td>16</td><td>18</td><td>20</td><td>22</td><td>24</td><td>26</td><td>28</td><td>29.6</td><td>m</td> </tr> <tr> <td>5000</td><td>4910</td><td>4030</td><td>3410</td><td>2950</td><td>2590</td><td>2300</td><td>2070</td><td>1880</td><td>1710</td><td>1600</td><td>kg</td> </tr> </table>	11,8	12	14	16	18	20	22	24	26	28	29.6	m	5000	4910	4030	3410	2950	2590	2300	2070	1880	1710	1600	kg												
11,8	12	14	16	18	20	22	24	26	28	29.6	m																										
5000	4910	4030	3410	2950	2590	2300	2070	1880	1710	1600	kg																										
		<table border="1"> <tr> <td>20,1</td><td>22</td><td>24</td><td>26</td><td>28</td><td>30</td><td>32</td><td>34</td><td>36</td><td>38</td><td>40</td><td>m</td> </tr> <tr> <td>2500</td><td>2250</td><td>2030</td><td>1840</td><td>1690</td><td>1550</td><td>1440</td><td>1340</td><td>1250</td><td>1170</td><td>1100</td><td>kg</td> </tr> </table>	20,1	22	24	26	28	30	32	34	36	38	40	m	2500	2250	2030	1840	1690	1550	1440	1340	1250	1170	1100	kg											
20,1	22	24	26	28	30	32	34	36	38	40	m																										
2500	2250	2030	1840	1690	1550	1440	1340	1250	1170	1100	kg																										
		<table border="1"> <tr> <td>21,4</td><td>22</td><td>24</td><td>26</td><td>28</td><td>29.6</td><td>m</td> </tr> <tr> <td>2500</td><td>2410</td><td>2180</td><td>1980</td><td>1810</td><td>1700</td><td>kg</td> </tr> </table>	21,4	22	24	26	28	29.6	m	2500	2410	2180	1980	1810	1700	kg																					
21,4	22	24	26	28	29.6	m																															
2500	2410	2180	1980	1810	1700	kg																															
		<table border="1"> <tr> <td>17,3</td><td>18</td><td>20</td><td>22</td><td>24</td><td>26</td><td>28</td><td>30</td><td>32</td><td>34</td><td>36</td><td>38</td><td>40</td><td>m</td> </tr> <tr> <td>3000</td><td>2860</td><td>2520</td><td>2250</td><td>2030</td><td>1840</td><td>1690</td><td>1550</td><td>1440</td><td>1340</td><td>1250</td><td>1170</td><td>1100</td><td>kg</td> </tr> </table>	17,3	18	20	22	24	26	28	30	32	34	36	38	40	m	3000	2860	2520	2250	2030	1840	1690	1550	1440	1340	1250	1170	1100	kg							
17,3	18	20	22	24	26	28	30	32	34	36	38	40	m																								
3000	2860	2520	2250	2030	1840	1690	1550	1440	1340	1250	1170	1100	kg																								
		<table border="1"> <tr> <td>18,4</td><td>20</td><td>22</td><td>24</td><td>26</td><td>28</td><td>29.6</td><td>m</td> </tr> <tr> <td>3000</td><td>2710</td><td>2420</td><td>2180</td><td>1980</td><td>1810</td><td>1700</td><td>kg</td> </tr> </table>	18,4	20	22	24	26	28	29.6	m	3000	2710	2420	2180	1980	1810	1700	kg																			
18,4	20	22	24	26	28	29.6	m																														
3000	2710	2420	2180	1980	1810	1700	kg																														
	<table border="1"> <tr> <td>3</td><td>14</td><td>m</td> </tr> <tr> <td>4000</td><td>4000</td><td>kg</td> </tr> </table>	3	14	m	4000	4000	kg		<table border="1"> <tr> <td>3</td><td>14</td><td>m</td> </tr> <tr> <td>3000</td><td>3000</td><td>kg</td> </tr> </table>	3	14	m	3000	3000	kg																						
3	14	m																																			
4000	4000	kg																																			
3	14	m																																			
3000	3000	kg																																			

Eckdrücke | Reactions | Réactions | Reazioni | Reacciones | Reacções

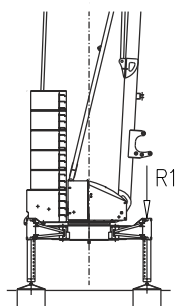

R1 ● 31 t ■ 24 t

▲ 17.5 t ○ 30.6 t

- Reaktionskräfte in Betrieb | Reazioni in servizio | Reactions in service | Réactions en service
Reacciones en servicio | Em serviço
- Reaktionskräfte außer Betrieb | Reazioni fuori servizio | Reactions out of service | Réactions hors service
Reacciones fuera de servicio | Fora de serviço
- ▲ Konstruktionsgewicht ohne Transportachse | Peso della gru senza assali | Dead weight without transport axles
Poids de construction sans eissieux | Peso de la grua sin tren de transporte | Peso de grua sem carro de transporte
- Ballastgewicht | Peso zavorra rotante | Ballast weight | Poids du lest
Peso de lastre | Peso de lastre rotativo

KK1140

Montage | Montage | Erection | Montaggio | Montaje | Montagem

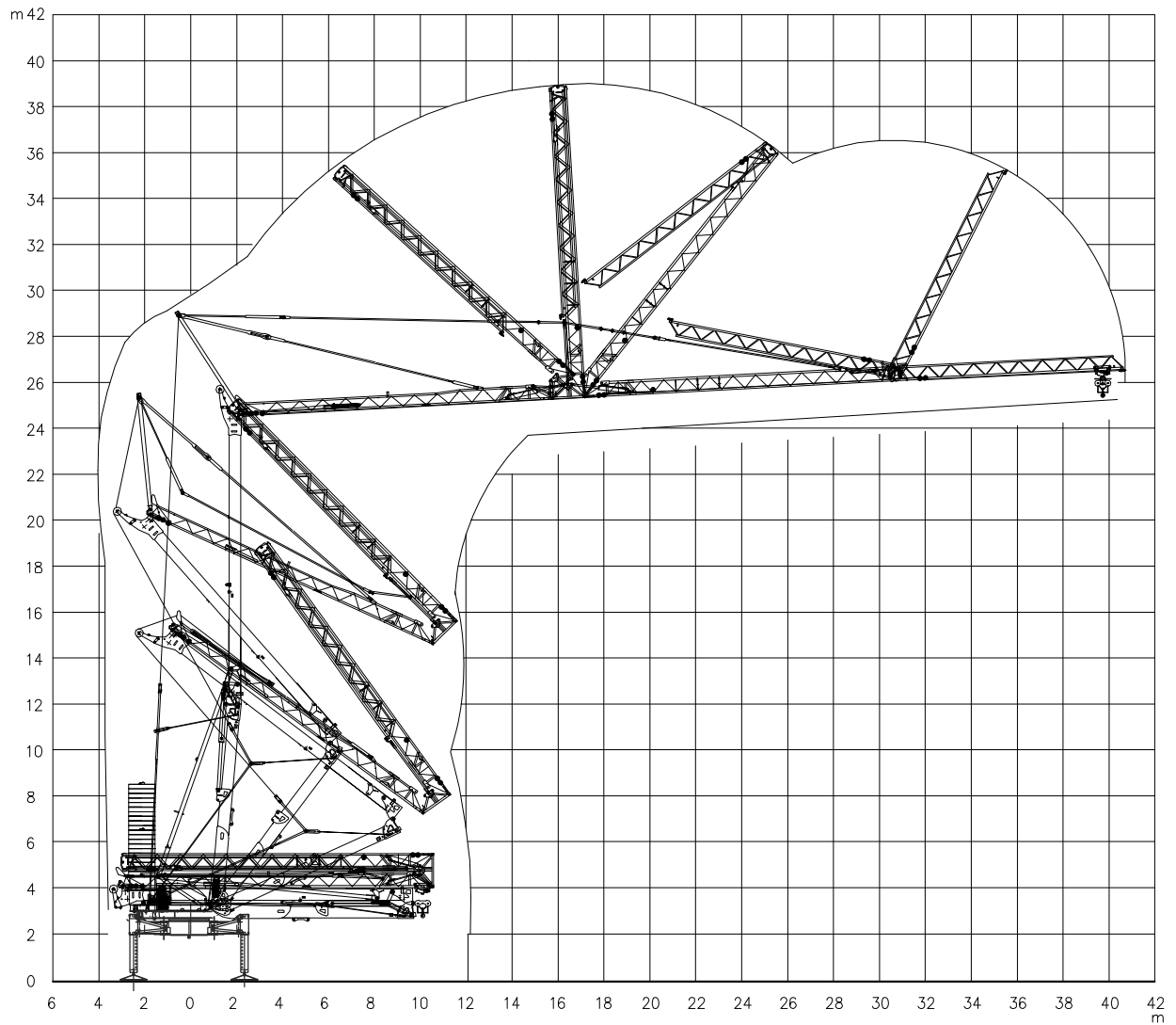



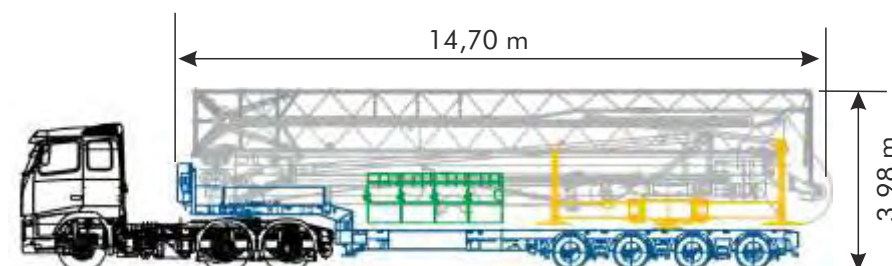





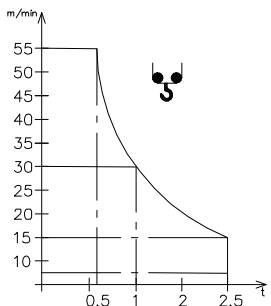
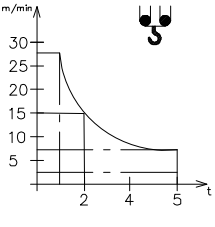

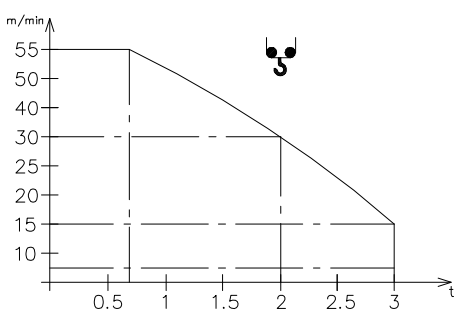
Transport | Transport | Transport | Trasporto | Transporte



KK1 140

Antriebe | Mechanisms | Mécanismes | Meccanismi | Mecanismos

V12.40 Sollevamento Hoisting Levage Heben Elevaciòn Elevaçao	m/min							V12.40 8.8 kW (12 Hp) 18 kVA 
	t	4	15	30	55			
V15.45 Sollevamento Hoisting Levage Heben Elevaciòn Elevaçao	m/min						V15.45 11 kW (15 Hp) 20 kVA 	
	t	3	3	2.0	0.7			

Carrello Trolleying Distribuciòn			1a	0 → 45	m/min	2.2 kW / 3 kW
			2a	0 → 45		
			3a	0 → 45		
			1a	0 → 17	m/min	3 kW
			2a	0 → 17		
			3a	0 → 17		
Rotazione Slewing Orientaciòn			1a	0 → 0.8	giri/min tr/min rp/min	2.2 kW
			2a	0 → 0.8		
			3a	0 → 0.8		

Rete elettrica | Réseau | Mains supply | Netzstrom | Red | Rede electrica 400 V - 50 Hz

Potenza elettrica necessaria | Puissance électrique nécessaire | Necessary electric power V12.40 18 kVA
Anschlusswert | Potencia electrica necesaria V15.45 20 kVA

Conforme alla direttiva 2000/14/CE sul livello acustico
Conforme à la directive 2000/14/CE sur le niveau acoustique
In compliance with the 2000/14/CE instruction on noise level
Germäss EWG-Richtlinie 2000/14/CE über Schall-Leistungspegel
Conforme con la direttiva 2000/14/CE sobre el nivel acustico FEM 1.001 – A3